



Portable Data Collector

Z-2121 series

(Version 1.00)

User's Manual



ZEBEX INDUSTRIES INC.
WWW.ZEBEX.COM

Table of Contents

| | |
|---|-----------|
| Preface | |
| About This Manual | 5 |
| Symbols used in this manual | 5 |
| Copyright | 6 |
| Safety Information | 6 |
| Laser Safety | 6 |
| Safety Operation | 7 |
| Federal Communication Commission (FCC) Statement | 8 |
| | |
| Unpacking | |
| Package Contents | 9 |
| Optional Parts | 10 |
| Cradle package | 10 |
| Purchaseable accessories | 10 |
| General Guide | 11 |
| | |
| Getting Start | |
| Inserting the Battery | 12 |
| Remove the Battery | 13 |
| Charging the Battery | 14 |
| Charging by cable | 14 |
| Charging by cradle | 14 |
| Charging the Battery Separate in the Cradle | 16 |
| PC System Requirements | 17 |
| Connecting To PC | 17 |
| Connecting via USB Cradle | 17 |
| Connecting the Z-2070 directly via USB cable | 18 |
| About The Product | 19 |
| Prerequisites | 21 |
| Specifications | 22 |
| | |
| Start to operate the Z-2121 | |
| Firmware Operation and Start Guide | 23 |
| | |
| 0. Power-on Screen | |
| 0.1. User Reset | 23 |
| 0.2. System Manual | 24 |
| | |
| 1. Run Task Function | 25 |
| | |
| 2. Task Utility Function | 25 |
| 2.1. File Status Function | 26 |
| 2.2. Data Format Function | 26 |
| 2.3. Delete Data Function | 27 |
| 2.4. Delete Task Function | 27 |
| | |
| 3. Setup Function | 28 |
| 3.1. Basic Setup Function | 28 |
| 3.1.1. Backlight & LCD Contrast Function | |

| | | |
|----------|---------------------------------------|----|
| 3.1.1.1. | Back Light Function..... | 29 |
| 3.1.1.2. | LCD Contrast Function..... | 29 |
| 3.1.2. | Beep Volume Function..... | 29 |
| 3.1.3. | Auto Power Off Function..... | 30 |
| 3.2. | System Setup Function..... | 30 |
| 3.2.1. | Communication Function..... | 31 |
| 3.2.1.1. | Communication Parameter Function..... | 31 |
| 3.2.1.2. | On Line Upload Function..... | 32 |
| 3.2.1.3. | Timeout Value Function..... | 32 |
| 3.2.2. | System Timer Function..... | 33 |
| 3.2.3. | ID/PN/Date Mode Function..... | 33 |
| 3.2.3.1. | Device ID Function..... | 34 |
| 3.2.3.2. | Password Function..... | 34 |
| 3.2.3.3. | Date Mode Function..... | 35 |
| 3.3. | Barcode Setup Function..... | 35 |
| 3.3.1. | Basic Set Function..... | 36 |
| 3.3.2. | Advance Set Function..... | 36 |
| 3.3.3. | Pre/Postamble Function..... | 36 |
| 4. | Auto Scan Operation..... | 37 |
| 5. | Bootload Function..... | 38 |

Preface

About This Manual

Thank you for your purchase of the ZEBEX Z-2121 Portable Data Collector. ZEBEX Z-2121 product is at the forefront of data collector technology, and this manual will provide the necessary information on the many and varied options available to you.

The Z-2121 product is a compact, ergonomic, modular and durable data collector. It is designed for easy upgrade with an integrated BT communication, 1D barcode scanner and vibration. The design is ideal for the mobile worker as it simple and easy to use anywhere along a supply chain.

Symbols used in this manual



A triangular shape indicates you should exercise caution.



A circle shape indicates something you should not to do.



A black circle indicates something you must to do.



A note symbol indicates you the information that is important and you should be observed.

Copyright

ZEBEX Industries Inc. makes no warranty of any kind with regard to this material. Including but not limited to the imply warranties of merchantability and fitness for a particular purpose. ZEBEX Industries Inc. shall not be liable for errors contained herein or for incidental consequential damages in connection with the furnishing, performance or use of this product.

ZEBEX Industries Inc. will be under no liability in respect of any defect arising from fair wear and tear, willful damage, negligence, abnormal working conditions, failure to follow the instructions and warnings, or misuse or alteration or repair of the products without written approval.

No part of this document may be reproduced, transmitted, stored in a retrieval system, transcribed or translated into any language or computer language in any form or by any means electronic, mechanical, magnetic, optical, chemical, manual or otherwise, with express writ- ten consent and authorization.

We reserve the right to make changes in product design without reservation and without notification. The material in this guide is for information only and is subject to change without notice.

ZEBEX is a registered trademark of ZEBEX INDUSTRIES INC.

© Copyright 2009 ZEBEX.

Safety Information

Your safety is of the utmost importance so please observe and follow the following guidelines that allow you to use the scanner in a safe and responsible way.

Laser Safety

The Z-2121 series Portable Data Collector complies with safety standard IEC825-1(1993) for a Class 2 laser product. It also complies with U.S.21CFR1040 as applicable to a Class II laser product. Avoid staring at direct laser light as the laser beam may hurt your eyes.

LASER BEAM

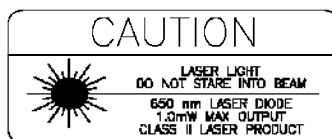

Never look directly into the laser beam.
Doing so can cause serious eye damage.

Safety Operation

WARNING



Disassembly and Modification

Never try to disassemble or modify the device in any way. All servicing should be carried out by qualified Zebex personnel or Zebex- approved engineers.



Interior Parts and Components

Never touch interior high voltage parts or components. Doing so creates the danger of electrical shock.



Drop and Knock the Device

Be careful when using the device; do not drop or knock the device as irreversible damage to the unit may occur.



Extreme temperature

Do not operate the device under extreme temperature.



Battery and Charger

The use of third-party battery or charger may either damage the device or shorten the life of the device.

CAUTION



Dropping and Damage

Should the device be dropped and damaged, immediately turn off the power and contact your original dealer or an authorized ZEBEX service provider. Continued use creates the danger of fire and electrical shock.



Abnormal Conditions

Should the device become hot or start to emit smoke or an original dealer or an authorized ZEBEX service provider. Continued use creates the danger of fire and electrical shock.



Foreign Objects

Should any foreign matter ever get into the device, immediately turn off the power and contact your original dealer or an authorized ZEBEX service provider. Continued use creates the danger of fire and electrical shock.



Moisture

Keep the device away from vases, planters, cups, glasses and other containers of liquid. Also keep it away from metal. Water and metal getting into the device creates the danger of fire and electrical shock.

Federal Communication Commission (FCC) Statement

15.21

You are cautioned that changes or modifications not expressly approved by the part responsible for compliance could void the user's authority to operate the equipment.

15.105(b)

This equipment has been tested and found to comply with the limits for a Class B digital device, pursuant to part 15 of the FCC rules. These limits are designed to provide reasonable protection against harmful interference in a residential installation. This equipment generates uses and can radiate radio frequency energy and, if not installed and used in the accordance with the instructions, may cause harmful interference to radio communications. However, there is no guarantee that interference will not occur in a particular installation. If this equipment does cause harmful interference to radio or television reception, which can be determined by turning the equipment off and on, the user is encouraged to try to correct the interference by one or more of the following measures:

- Reorient or relocate the receiving antenna.
- Increase the separation between the equipment and receiver.
- Connect the equipment into an outlet on a circuit different from that to which the receiver is connected.
- Consult the dealer or an experienced radio/TV technician for help.

Operation is subject to the following two conditions: This device may not cause interference;

This device must accept any interference, including interference that may cause undesired operation of the device.

FCC RF Radiation Exposure Statement

This equipment complies with FCC radiation exposure limits set forth for an uncontrolled environment. End users must follow the specific operating instructions for satisfying RF exposure compliance. This transmitter must not be co-located or operated in conjunction with any other antenna or transmitter.

Unpacking

Package Contents



Z-2121 series
Portable Data Terminal

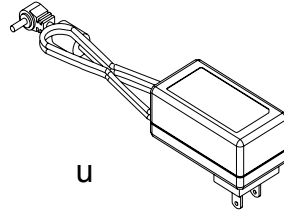

u
AC Adapter

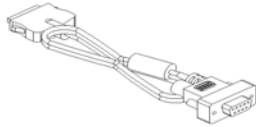

RS-232 DB9 (F) Cable

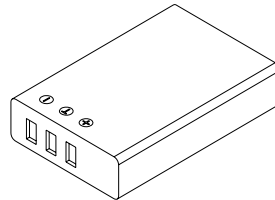

Battery Pack

Optional Parts

Cradle package



RS-232 Docking Cradle



USB Docking Cradle

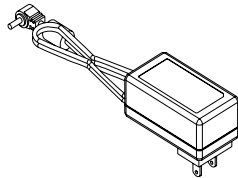

AC Adapter

Purchaseable accessories

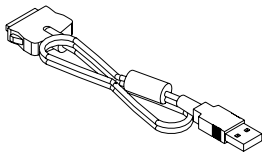

USB Cable

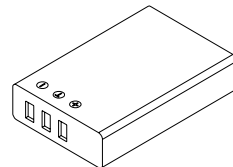

Main Battery

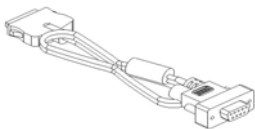

RS-232 DB9 (F) Cable

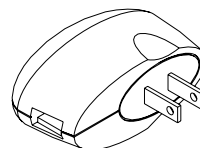

USB AC Adapter

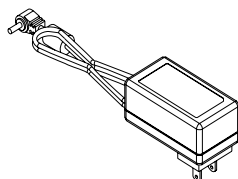

AC Adapter

General Guide



| | | |
|---|-----------------------|--|
| 1 | LED indicator (Right) | Indicates the status of battery charge : Red for battery just on charging and Green for full. |
| 2 | LCD screen | Display various data when a program is being run. |
| 3 | Scan button | The trigger of Barcode reading. |
| 4 | Keypad | A total of 26 keys are provided to the power and other function keys. |
| 5 | Scan windows | Emits a laser for bar code reading. |
| 6 | Battery | Main battery |
| 7 | Communication port | Communication with PC or charge by USB port |

Getting Started

Inserting the Battery

When inserting the battery for the first time, follow these directions:

1-3. Push the top lock to pick up the battery pack.

5-4. Insert the battery as shown.

6-7. Put the battery cover back.

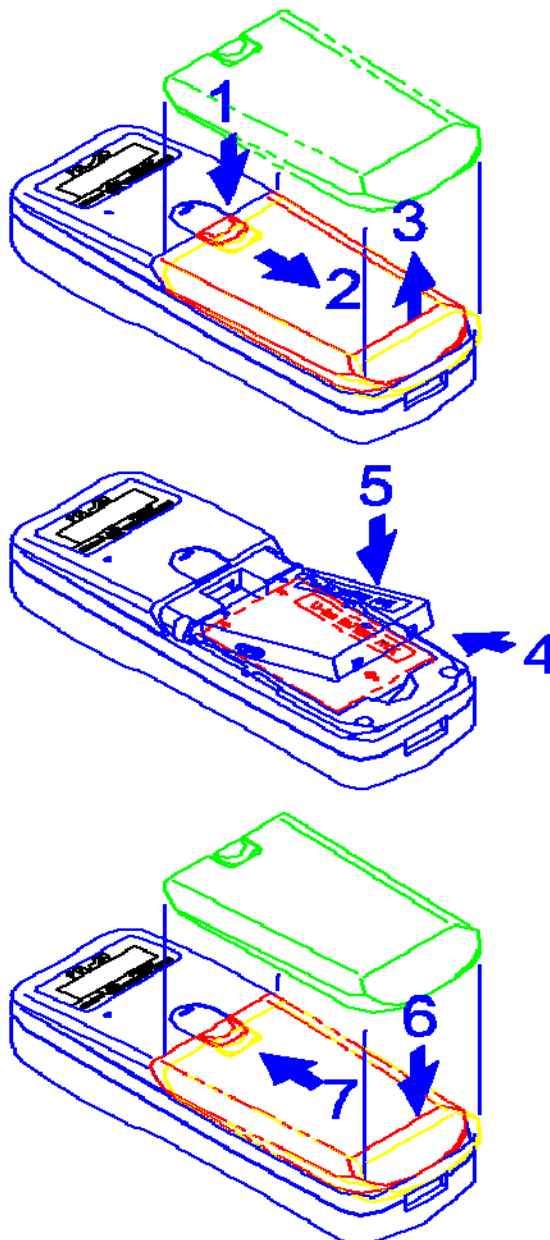

Remove the Battery

1. Turn the power off.
2. Remove the back cover.
3. Press the battery against the **Z-2121** terminal, and lift it up and away from the compartment.
4. **Put the cover back.**

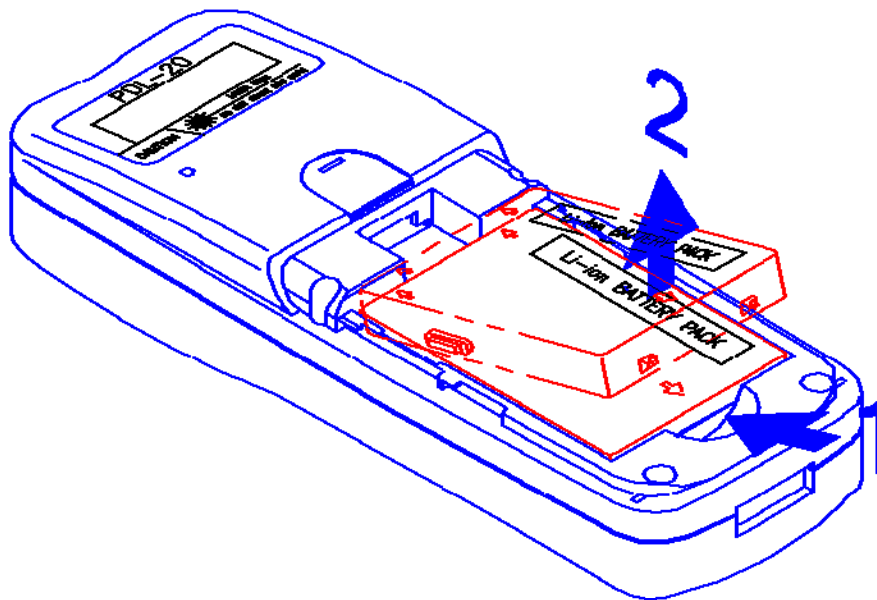

Charging the Battery

The Li-ion rechargeable battery can be charged while inserted in the device itself or independently via the recharging slot at the back of the cradle.

Charging by cable

Connect the RS-232 DB9 (F) Cable and 9V AC adaptor as shown.

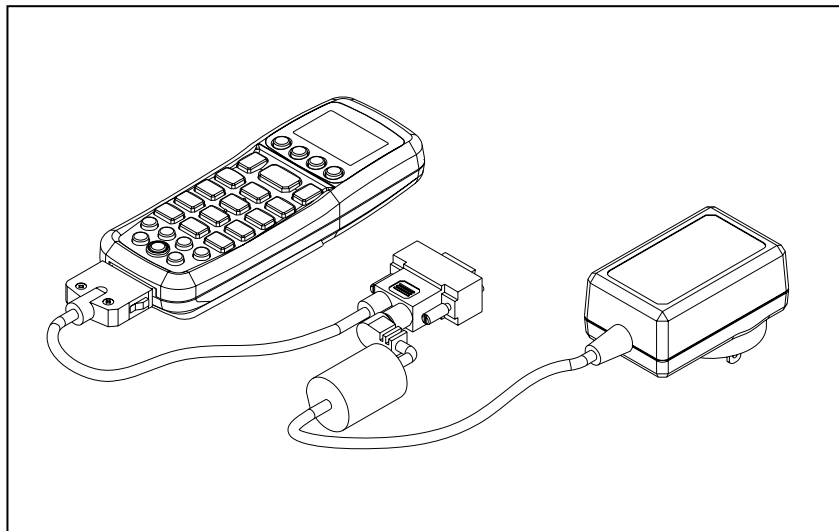

Charging by cradle

1. Put the **Z-2121** on the cradle as shown in figure 2.
2. Connect the power adapter to the DB-9 (female) connector
3. Insert the power adapter to the wall socket.

Note 1:

1. The cradle can be connected both to the power adaptor for battery charging and to the host computer for data uploading as well as downloading at the same time.
2. To charge the battery, connect the power plug of the power supply into the power jack on the **DB-9** female connector.
3. The **DB-9** (female) connector is used for battery charging and/or communication with the PC.

4. Battery charging and data exchange can be done at the same time or respectively. The **Z-2121** Data Collector, however, is unable to communicate with the host computer when placed on the cradle without the battery attached to it.
5. The battery is always charged via the cradle. There are two ways to charge the battery. First, take the battery out from the **Z-2121**, and insert it in the back slot of the cradle for fast charging, as shown in Fig 3, which takes about 3 hours before it is fully charged; second, put the battery in the **Z-2121**, and place it on the cradle, with the **Z-2121** either on or off, for slow charging, as shown in Fig 2. This will need approximately 6 hours. To maximize the battery's life span, it is recommended that slow charging be adopted unless there is a need for fast charging.
6. While the battery is being charged within the **Z-2121** on the cradle, data can still be exchanged between the PC and the **Z-2121** via the DB-9 connector and the RS-232 port.
7. The battery should stay on the cradle (either with the terminal or independently) for at least 12 hours before being used the first time or after months of idleness.

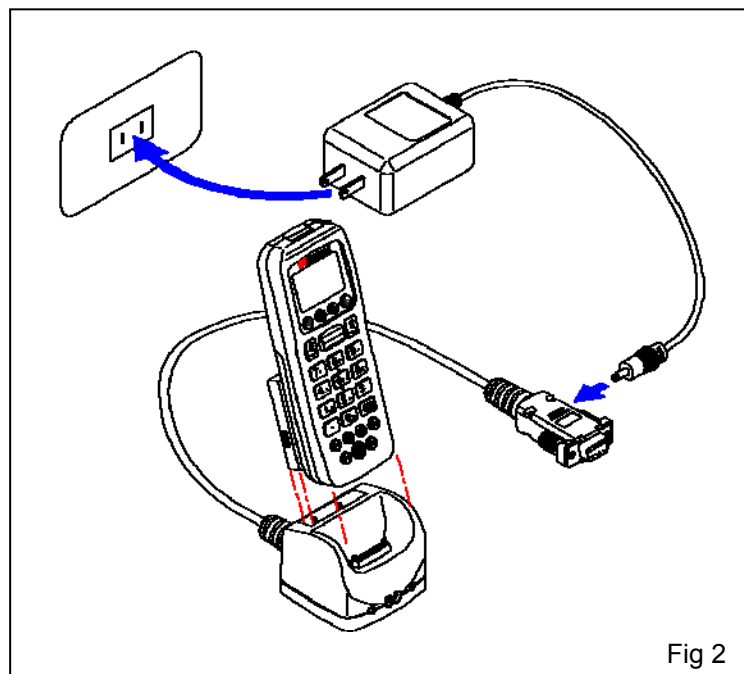
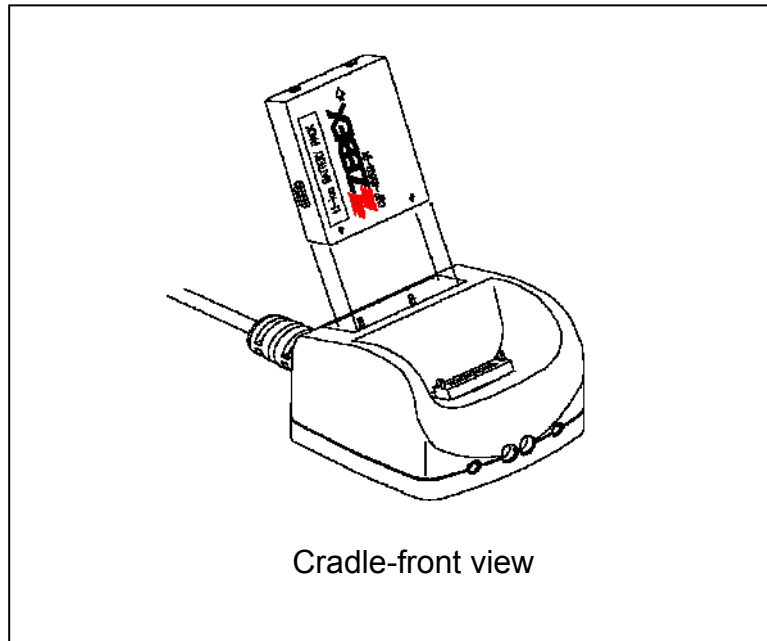

Fig 2

Charging the Battery separately in the cradle

Insert the battery into the compartment at the rear of the cradle.



Connect the power jack to the cradle and plug AC adapter into the socket.



NOTES

When charging the battery for the first time, charge for at least 12 hours prior to use.

PC System Requirements

Windows XP Operating System
64 MB RAM
50 MB free HDD space
USB ports communication Interface
Bluetooth transmitter/receiver (optional)

Connecting To PC

In order to use the software supplied with the Terminal, the mobile data terminal must be connected to a PC.

Connecting via USB Cradle

The cradle must also be connected via one of your PC's RS-232 ports. Attach one end of the cable to the RS-232 interface on your PC.

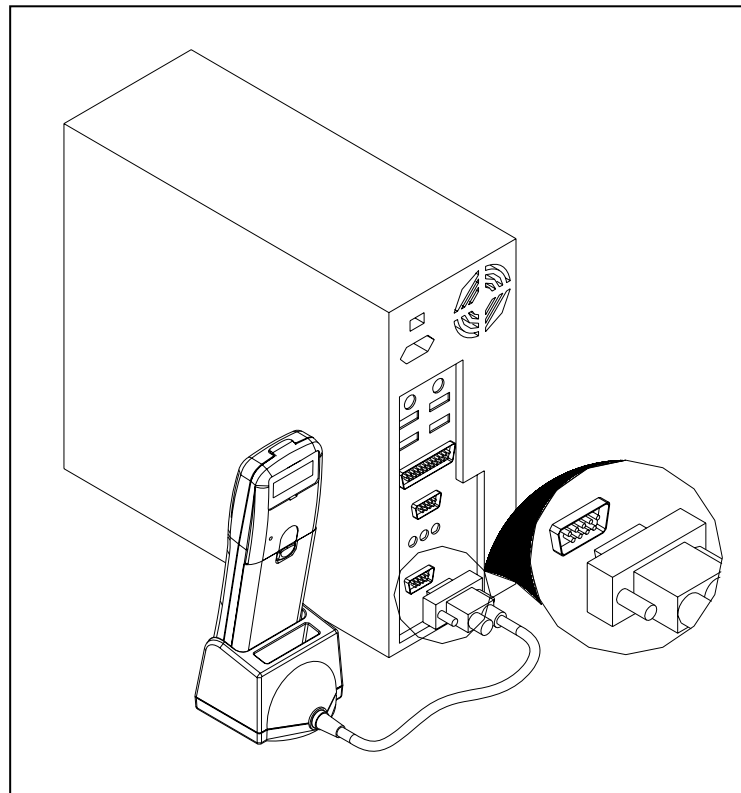

Connecting the Z-2121 directly via USB cable

You can connect the Z-2121 directly to your PC, without the need for the cradle, using the USB cable, attaching it to the port on the left hand side of the device.

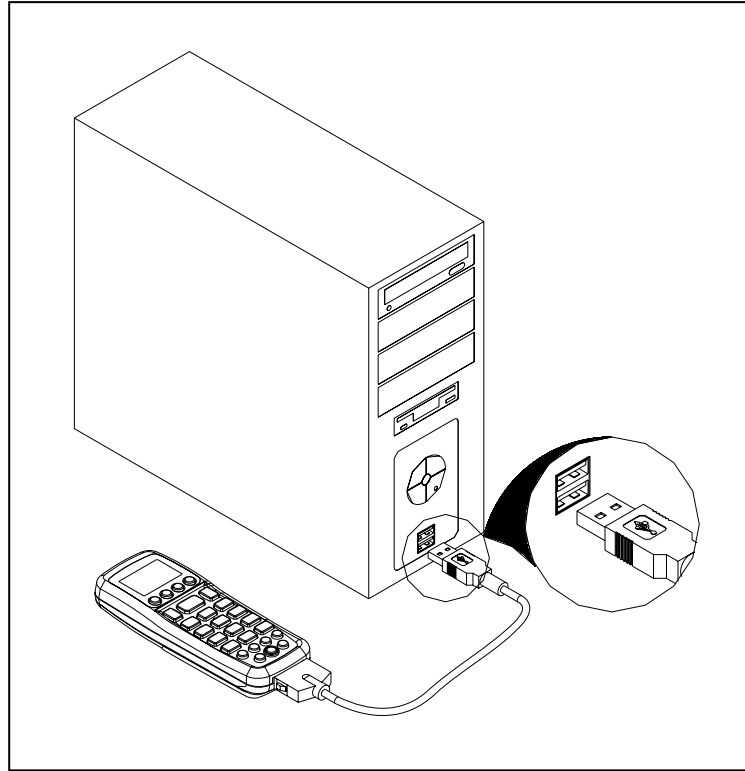

About The Product

The Z-2121 is a compact, ergonomic and durable portable data collector. It is designed with an integrated Bluetooth communication and 1D laser barcode scanner and 26-keys keypad. The design is ideal for the mobile worker as it simple and easy to use anywhere along a supply chain.

The Z-2070 features a 32-bit C-MOS Microprocessor. This combination delivers high performance, low power consumption and the diversity of a Bluetooth communication. Compared with other systems currently available on the market, Z-2121 is the most cost-effective to offering optimum performance.

Features

Hardware features

- a. Compact size, lightweight, elegant, and easy to carry on the waist strap by means of a tab mounted on the back of the unit and a clip attached to the user's waist strap.
- b. Ergonomic design, operated with one hand, easy to capture data.
- c. Low power consumption. Good for 48-hour operation after a full charge.
- d. Auto shut-off function reduces power consumption and extends battery life.
- e. Built-in **FREETASK** allows the **PDL-20** to be used for data collecting without outside supports.
- f. Programmable functions support WinTask Gen. for special data collection.
- g. Built-in Laser scanner as input device.
- h. Built-in Real Time Clock for time-stamp.
- i. Tone controllable buzzer.
- j. A lithium back-up battery for memory protection.
- k. Low-battery detecting circuit and low-power warning device.
- l. RS-232C communication port.

Note:

- a. The **FREETASK** is a built-in simple Data Base system with which you can define your own storage structure for data collection operation.
- b. Win Task Gen. is a Windows based utility program with which you can design the procedure for specified tasks and

execute designed tasks on the data terminal.

Firmware features

- a. Supports most of the popular barcode symbols.
- b. Ability to discriminate among barcodes
- c. Programmable auto-power-off time
- d. The uploading or downloading can be fully controlled by the computer.
- e. Easy user-defined **FREETASK**, able to assign as many as 16 fields
- f. Ability to execute as many as 8 TASK

Development Software features

- a. Windows 95/98/NT based WinTask Gen.
- b. Able to remotely program all functions as long as the terminal (including the decoder) is connected to PC via the cradle.
- c. Ability to upload data to PC
- d. The **FREETASK** may be downloaded (from PC) to the terminal
- e. In addition to the **FREETASK**, as many as 8 TASKs may be downloaded to the terminal
- f. Ability to edit TASK to execute specified data collecting tasks.

Cradle features

- a. A special recharging circuit ensures recharging effects and security of the lithium Ion battery during recharging.
- b. Able to communicate with PC using a widely used RS-232 or USB interface as shown in Fig 6.

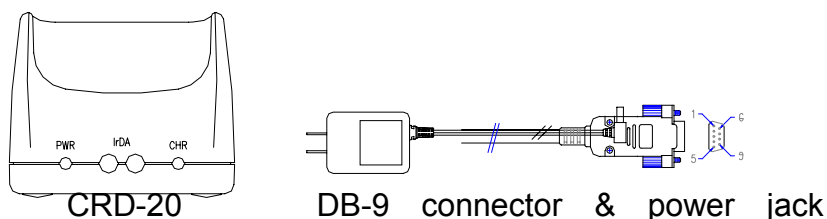

Fig 6

Note:

There are 2 LEDs and 2 holes at the front bottom of the **CRD-20** as shown in Fig 6. The 2 LEDs are located on the left and right, whereas the two holes in the middle. The LED on the left is illuminated when power is on, and will not be illuminated if the power adaptor is not connected to the AC output, or the 9VDC jack is not inserted into the RS-232 connector. The LED on the right is illuminated when a battery is put in the back slot of the cradle for recharge. It will remain illuminated as long as recharging is going on until a full charge is achieved. It flashes intermittently, however, when the battery slot is empty, indicating that the cradle is detecting the presence of the battery. The LED at the upper-right corner of the terminal is illuminated when the terminal is placed on the cradle for a recharge, and will be off when a full recharge is achieved.

Prerequisites

Skills Required

The following skills are required by developers aiming to develop application software for the ZEBEX Z-2121 series.

- Good knowledge of one or more of the following:
 - * C language

Specifications

| | |
|-----------------------|---|
| SYSTEM | |
| Processor | ST 32-bit processor with Flash Area 256/512KB |
| Memory | SRAM - 2MB F-ROM – 8MB (S-FLASH) |
| LCD Display | FSTN 96x49 dot (6Lx16C) , with Backlight LCD |
| Keypad | 26 Keys without backlight |
| Audio | 1 X Mono Buzzer |
| POWER | |
| Main battery | PDL20,Sanyo-UF653048P 830mAh (V3688 Lithium-ion) |
| Backup battery | (3.0V, 25mAH Li-ion rechargeable battery) 2 weeks – data and RTC define by remove main battery keep time |
| Input Device | |
| Barcode scanner | Motolora SE-955 1D barcode Laser scanne engine |
| Indicator | |
| Power & Charging | 1 X LED Two color , Red for charging Green Good Read |
| Bluetooth | None Indicator |
| Vibration | Yes |
| Interface | |
| Cradle - RS-232 | With RS-232 cable (Full Function) |
| Terminal – USB Cable | Detect – USB cable function (Power by PC USB power detect or Travel Charge) |
| Radio | |
| Bluetooth | Bluetooth 2.0 compliance , CLASS I , DISTANCE=10~100M |
| Physical | |
| Dimensions | 134.9(L) x 23.6(W) x 48(H) mm |
| Weight | 125g |
| Color | Dark Gray |
| Environmental | |
| Rugged | (Resistance to fall impact : 1.0M in height) |
| Operating temperature | 0°C ~ 50°C |
| Storage temperature | -10°C ~ 60°C |
| Humidity | 95% non-condensing |
| Regulatory | |
| Safety regulation | FCC, CE, CE RF , RoHS, FCC RF , LVD |

Start to operate the Z-2121

Take out the terminal, install in a set of fully charged battery.

1. Press the **"Power"** key. After the display appears, press **"M2"** key to enter the System Menu.
2. Then Press **"1"** to enter the **"Run Task"** menu. Then press **"1"** again to execute the **"FREETASK"**.
3. Press **"SCAN"** to do barcode scanning and data collecting.

Firmware Operation Quick Start Guide

0. Power-on Screen

0.1 User Reset

Insert battery into the Z-2121, and the display will be shown in Fig 1.

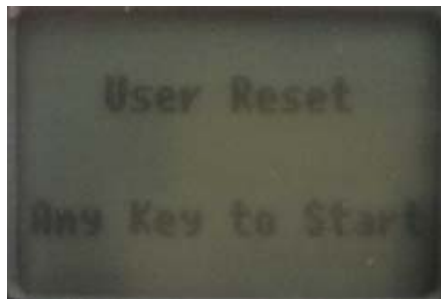

Fig 1

After display is shown in Fig 1, and then show to press any key to Fig 3 or can press ◀ ▶ key into Fig 2.



Fig 2

In Fig 2 is asked for clean the data or not, press **M2** to select Y or N, after confirmed to press **E** into Fig 3.

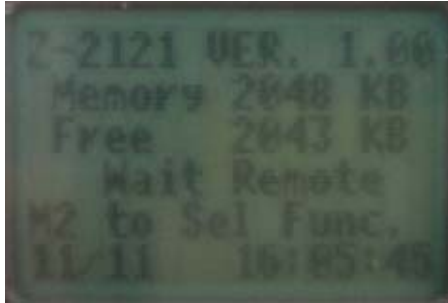

Fig 3

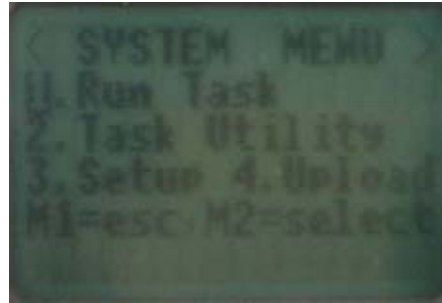

Fig 4

0.2 System Manual

In Fig 3 is shown of Z-2121 standard Firmware, press **M2** can enter into System Menu as Fig 4, and also can press **M1** back to Fig 3

The following is the description of each function:

1. Press “1” enter into Run Task function test.
2. Press “2” enter into Task Utility function test.
3. Press “3” enter into Setup Menu.
4. Press “4” to upload data to PC.

1. Run Task Function Test

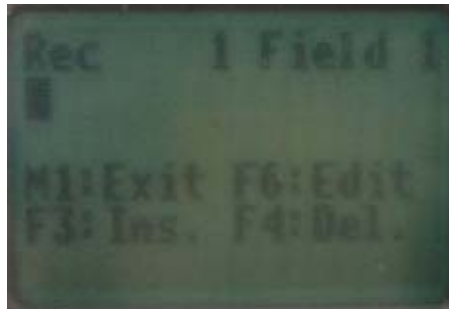

Fig 5

In Fig 5 is shown in barcode scan, press **SCAN** key to read barcode data, and the vibrator will shake once while scanning barcode.

If want to revise the barcode data, please press **F6** to show on the data and key in the number. And **F3** allow user to insert blink between digits in each records. Or can press **F4** to delete the data or number. And then press **M1** back Fig 5.

2. Task Utility Function Test

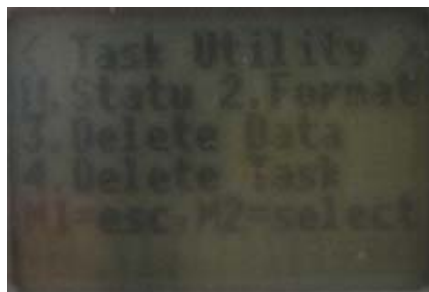

Fig 6

In Fig 6 is shown for Task Utility function, the following is the description of each function:

- 2-1.Press "1" enter into File Status function test.
- 2-2.Press "2" enter into Delete Data function test.
- 2-3.Press "3" enter into Backup function test.
- 2-4.Press "4" enter into Backup function test.

2.1 File Status Function Test



Fig 7

In Fig 7 is shown in the data amount, press **M1** can leave the screen.

2.2 Data Format Function Test

Enter Data Format Function Test, and the display will be shown in Fig 8. Press any key to start varies of format setting by field number shown as Fig 9.

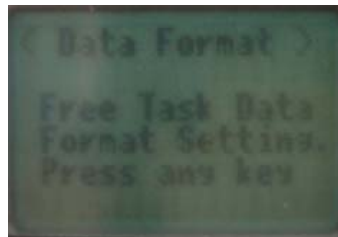

Fig 8

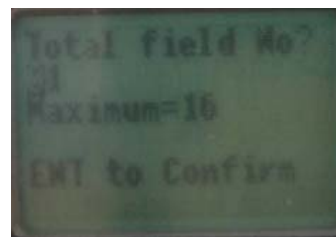

Fig 9

When setup was finished, go to next setup by pressing "**E**" button. Setup such as Input Device (Fig 10) / Length (Fig 11) / Prompt (Fig 12) / Editing (Fig 13) / Delay (Fig 14) / Time stamp (Fig 15) can be done in Data Format Function Test.



Fig 10



Fig 11

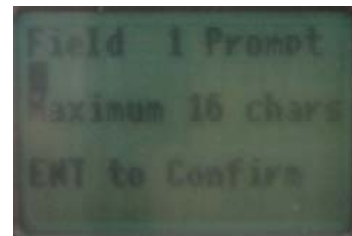

Fig 12

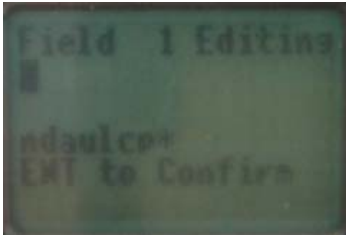

Fig 13

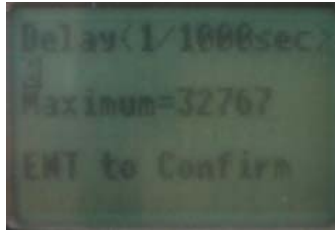

Fig 14



Fig 15

2.3 Delete Data Function Test



Fig 16

In Fig 16 is asked for deleting the data download from the PC or not, press **M2** is YES, press again is NO, after confirmed press **E** to leave the screen.

2.4 Delete Task Function

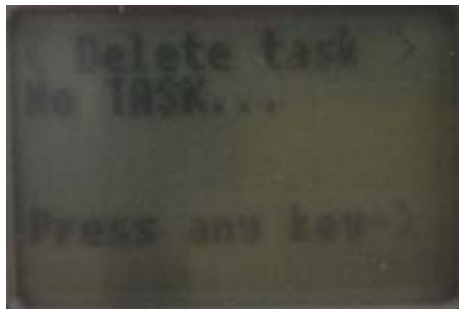

Fig 17

In Delete task function test, user can delete task installed within Z-2121. If there is no task, display will show as Fig 17.

3. Setup Function Test

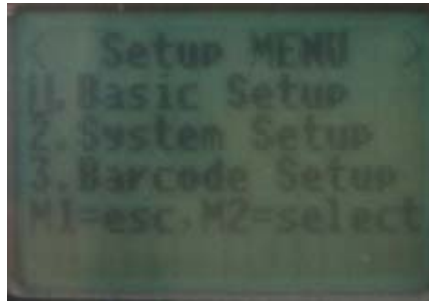

Fig 16

In Fig 16 is shown for Parameter function, the following is the description of each function:

- 3-1.Press **1** enter into Basic Setup function test.
- 3-2.Press **2** enter into System Setup function test.
- 3-3.Press **3** enter into Barcode Setup function test.

3.1 Basic Setup Function



Fig 17

In Fig 17 is shown for Backup function, the following is the description of each function:

- 3-1-1.Press **1** enter into BackLit & LCD function test.
- 3-1-2.Press **2** enter into Beep Volume function test.
- 3-1-3.Press **3** enter into Auto Power Off function test.

3.1.1.1 Back Light Function

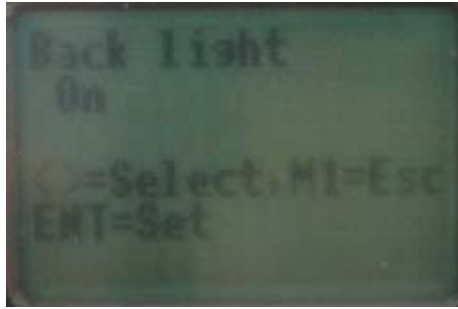

Fig 18

In Fig 18 is shown to select LCD back light, press ◀ or ▶ to switch ON or OFF, after confirmed press **E** to leave the screen.

3.1.1.2 LCD Contrast Function

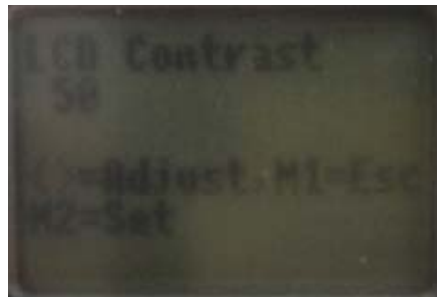

Fig 19

In Fig 19 is shown to select LCD contrast, the default is 45, press ◀ or ▶ to adjust the contrast, after confirmed press **E** to leave the screen.

3.1.2 Beep Volume Function

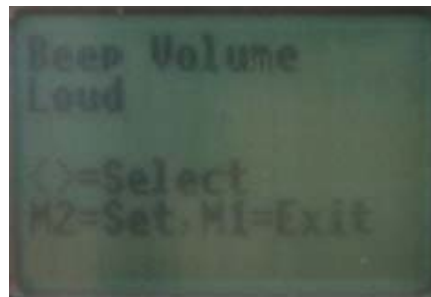

Fig 20

In Fig 20 is shown to select Beep Volume, the default is Loud, press ◀ or ▶ to adjust Quite, Low or Medium, after confirmed press **E** to leave the screen.

3.1.3 Auto Power Off Function



Fig 21

In Fig 21 is shown to set Auto Power Off, the default is 10mins, press ◀ or ▶ to adjust 15mins, 20mins, 30mins or Disable, after confirmed press **E** to leave the screen.

3.2 System Setup Function Test

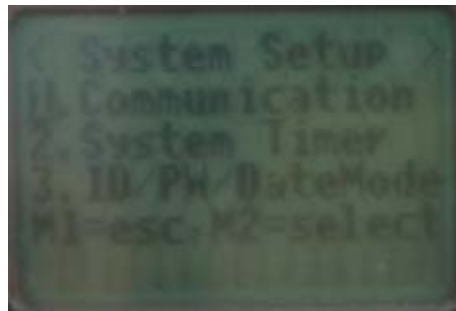

Fig 22

In Fig 22 is shown for System Setup function, the following is the description of each function:

- 3-2-1. Press **1** enter into Communication function test.
- 3-2-2. Press **2** enter into System Timer function test.
- 3-2-3. Press **3** enter into ID/PW/Date Mode function test.

3.2.1 Communication Function

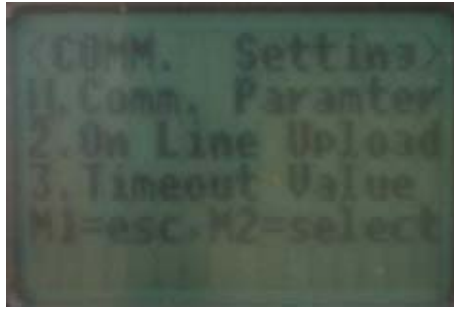

Fig 23

In Fig 23 is shown for System Setup function, the following is the description of each function:

- 3-2-1-1. Press **1** enter into Comm. Parameter function test.
- 3-2-1-2. Press **2** enter into On Line Upload function test.
- 3-2-1-3. Press **3** enter into Time Value function test.

3.2.1.1. Comm. Parameter Function Test



Fig 24

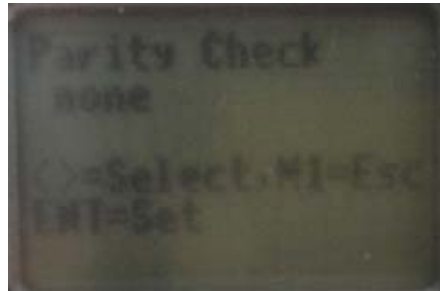

Fig 25



Fig 26



Fig 27

In Fig 24 is shown to set up the speed, press **◀** or **▶** to adjust 576000, 38400, 19200, 9600, 4800, 2400 or 8, after confirmed press **E** to enter into Fig 25.

In Fig 25 is shown to set up the parity, press , ◀ or ▶ to adjust even, odd, mark or space, after confirmed press **E** to enter into Fig 26.

In Fig 26 is shown to set up the data bit, after confirmed press **E** to enter into Fig 27.

In Fig 27 is shown to stop the data bit, after confirmed press **E** to enter into Fig 23.

3.2.1.2. On Line Upload Function



Fig 28

In Fig 28 is shown to set up On Line Upload Function, the default is off, press , ◀ or ▶ to adjust, after confirmed press **E** to leave the screen.

3.2.1.3 Timeout Value Function



Fig 29

In Fig 30 is shown to set up Timeout Value, the default is 10 times, press , ◀ or ▶ to adjust 10, 20, 50, 100, or normal, after confirmed press **E** to leave the screen.

3.2.2 System Timer Function



Fig 30

In Fig 31 is shown to set up the date, press number **1** key to adjust the number, after confirmed press **E** to enter set up the time.

Still, press number **1** key to adjust the number, after confirmed press **E** to leave the screen.

3.2.3 ID/PW/Date Mode Function



Fig 31

In Fig 31 is shown for ID/PW/Date Mode function, the following is the description of each function:

- 3-2-3-1. Press **1** enter into Device ID function test.
- 3-2-3-2. Press **2** enter into Password function test.
- 3-2-3-3. Press **3** enter into Date Mode function test.

3.2.3.1 Device ID Function



Fig 32



Fig 33

In Fig 32 is shown to set up the Device ID, after confirmed press **E** to enter into Fig 33, and press the number, after confirmed press **E** to leave the screen.

3.2.3.2 Password Function



Fig 34



Fig 35

In Fig 34 is shown to set up password, after setup press **E** to leave the screen, If there is no setting will enter into Fig 35 automatically, please press **E** to leave the screen.

3.2.3.3 Date Mode Function

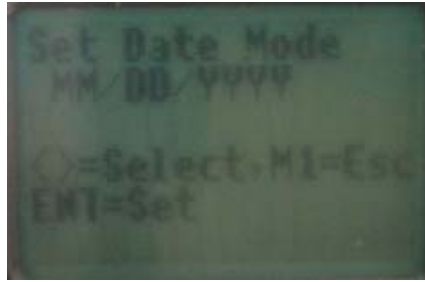

Fig 36

In Fig 36 is shown to set up Month, Date and Year, after setup press **E** to leave the screen.

3.3 Barcode Setup Function

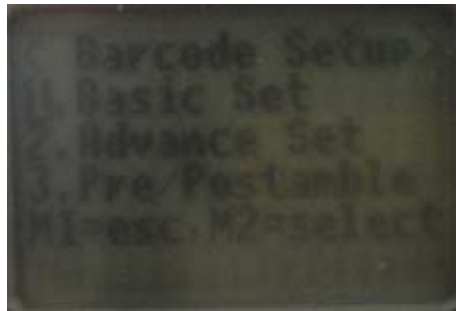

Fig 37

In Fig 37 is shown for BarSetup function, the following is the description of each function:

- 3-3-1. Press **1** enter into Basic Set function test.
- 3-3-2. Press **2** enter into Advance Set function test.
- 3-3-3. Press **3** enter into Pre/Postamble function test.

3.3.1 Basic Set Function

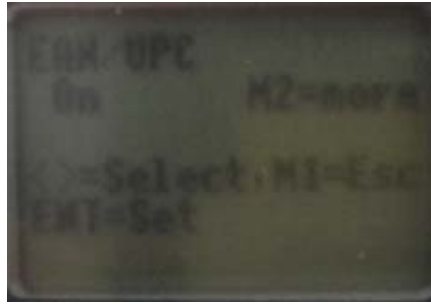

Fig 38

In Fig 38 is shown for Basic Set function, can adjust the barcode type like Code 39, F ASCII 39, Codabar, ITF25, Code 128 and Code 93, after confirmed press **E** to leave the screen.

3.3.2. Advance Set Function

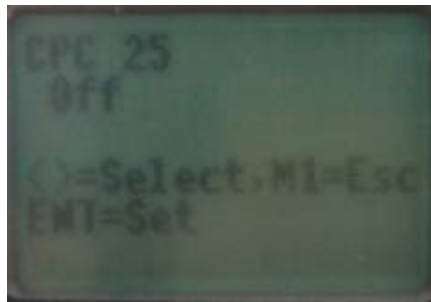

Fig 39

In Fig 39 is shown for Advance Set function, can adjust EAN to ISBN/ISSN, EAN-13 digits, EAN-8 digits, IATA code or Codabare ST/SP, after confirmed press **E** to leave the screen.

3.3.3. Pre/Postamble Function

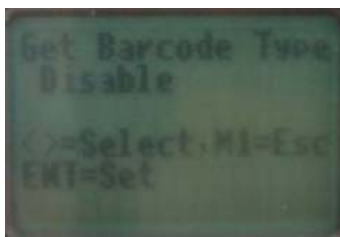

Fig 40

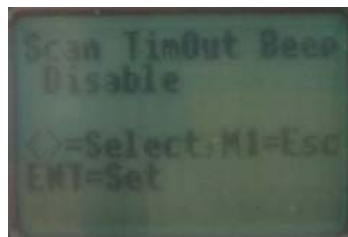

Fig 41



Fig 42

In Fig 40 is shown for Pre/Postamble function for determining which type of barcode need to be enable Pre/Postamble. After setup please enter into Fig 41 to setup Scan Time Out Beep, after confirmed press **E** to enter Fig 42 which is Pre and Posamble set up. After confirmed press **E** to leave screen.

4. Auto Scan Operation Process



Fig 43



Fig 44

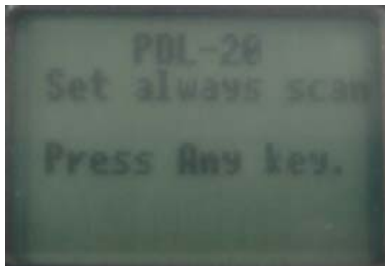

Fig 45

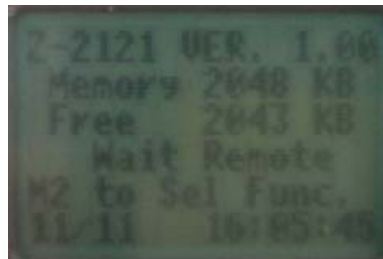

Fig 46

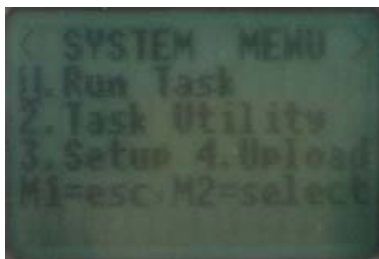

Fig 47

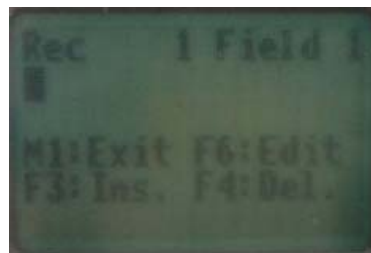

Fig 48

In Fig 43 is shown on the screen of first time turn on the Z-2121 and then enter into Fig 44 by pressing **◀▶** key. Select “Y” to Clear All Data. After 2 seconds, press **F5+F6** at the same time, the display will show as Fig 45 and enter into Fig 46. Press **M2** key to enter Fig 47 and press 1 entering into Auto Scan mode.

5. Bootload Function Quick Start Guide

Insert battery into the Z-2121, and the display will be shown in Fig 49.



Fig 49



Fig 50

In Fig 49 is shown on the display after Z-2121 power on, press **F1 + F2** will show in Fig 50 for the Bootloader function. Press "**M1**" key to adjust wait host data 115200 / 57600 / 38400 / 19200 / 9600 / 4800. After confirmed press **E** to leave screen.

<< MEMO >>